

SERIES  
**BREZZA**

TECHNICAL MANUAL

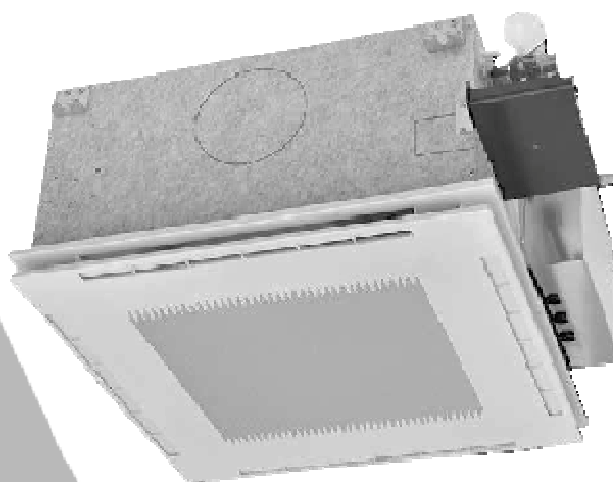

NEW  
WATER CASSETTE





## CONTENTS

1-INTRODUCTION .....	4
2-APPLICATION LIMITS .....	4
3-THE COANDA EFFECT .....	4
4-CODES INTERPRETATION KEY .....	6
5-TECHNICAL SPECIFICATIONS .....	6
6 - TECHNICAL DATA (AC motors) .....	8
6.1-Unit with 3-row coil.....	8
7 - TECHNICAL DATA (EC motors) .....	9
7.1-Unit with 3-row coil.....	9
8-DIMENSIONS AND WEIGHTS .....	10
9-ACCESSORIES.....	11
9.1-Valves (V) and auxiliary tray (ADPB).....	12
9.2-Auxiliary condensate drain pump (PSCC-BI) .....	13
9.3-Flange for ducted air delivery (FLMA) .....	14
9.4-Flange for outdoor air intake (FLAE) .....	14
9.5 - Metal cover for exposed installation (MECO) .....	15
9.6-Filter with Sanitized treatment (FA/SAN).....	17
9.7-High efficiency filter (FA/H) .....	17
9.8-Electrical heater (EH).....	17
10-Hygienic version .....	18
11-Electrical connections.....	20
11.1-Wiring diagram of cassette with AC motor .....	20
11.2-Wiring diagram of cassette with EC motor .....	21

## 1-INTRODUCTION

BREZZA series units are designed for air conditioning in the residential and commercial sector, for indoor installation in areas not exposed to freezing conditions or extreme temperatures and in a dust-free, non-explosive atmosphere. The manufacturer cannot be held liable for the consequences of incorrect use of the unit.

The BREZZA series is available both with traditional three-speed AC motors and with low consumption EC motors. The table below highlights the electricity savings that can be achieved with the EC motors (at the same machine operating points).

		73			93		
Speed		min	med	max	min	med	max
Air flow rate	m <sup>3</sup> /h	350	500	710	560	810	940
AC motor power	W	30	36	50	54	72	87
EC motor power	W	3	8	22	5	15	48
Difference		-90%	-78%	-56%	-91%	-79%	-45%

## 2-APPLICATION LIMITS

Electrical power supply	220 – 240V / 50Hz
Coil inlet water temperature	5 / 70°C
Return air temperature	12 / 50°C
Return air relative humidity	15 / 70%

The unit should only operate close to limit use values for short periods of time, because operation close to limit conditions for prolonged periods can reduce the normal lifetime of unit components.

## 3-THE COANDA EFFECT

The BREZZA series units are designed to ensure high levels of comfort. Annoying cold air draughts (usually the problem with cassette fan-coils) are avoided by the special shaping of the panel, which lets air into the environment with a COANDA effect.

The COANDA effect is the tendency of a jet of fluid to follow the outline of a nearby surface. Therefore the air flow follows the ceiling line, and then falls back on to the walls. Since at this point the air speed is very low, it will not cause any discomfort to people.

NEW WATER CASSETTE- TECHNICAL MANUAL

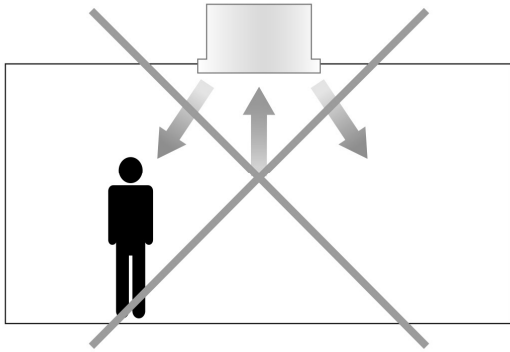

*Traditional cassette*

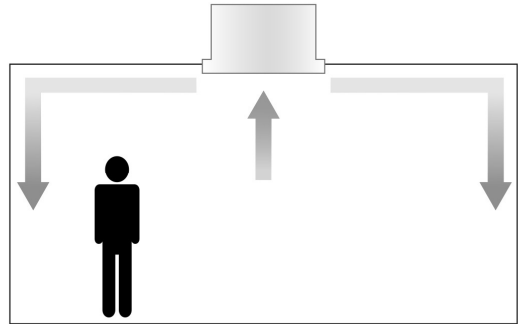

*Cassette with Coanda effect*

If the ceiling height exceeds 3m and therefore it is necessary to direct the air flow downwards, a panel with adjustable fins is available as an accessory. In this way it is possible to manually adjust the flow orientation for each one of the four deliveries: horizontal (with coanda effect), vertical or in an intermediate position.

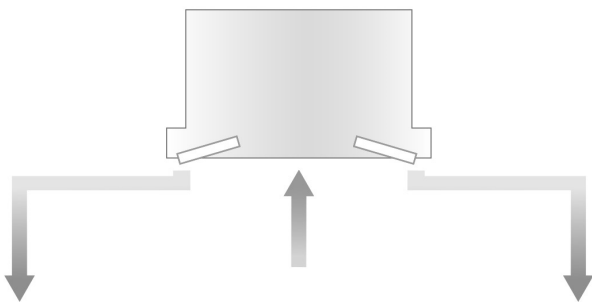

*Fins in horizontal position (coanda)*

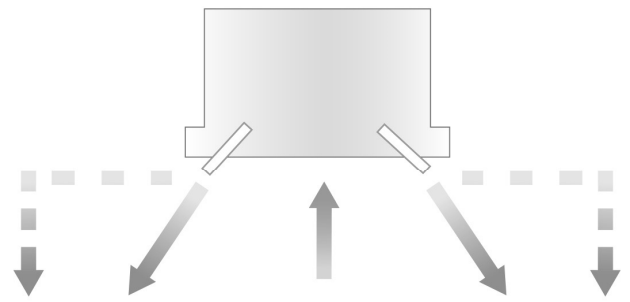

*Fins in vertical position*

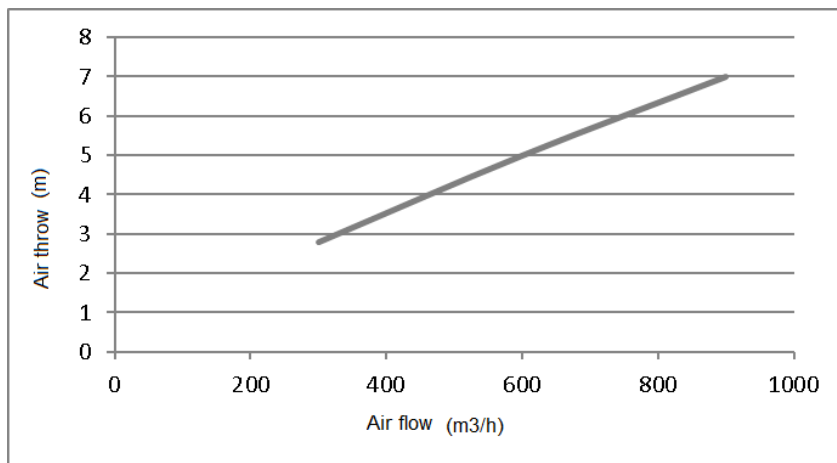

**CAUTION!** The difference in temperature between the delivery air and the ambient air can significantly influence the air throw.

## 4-CODES INTERPRETATION KEY

The standard version has a 3-row coil (for 2-pipe versions) or 1 plus 2-row coil (for 4-pipe versions), with fixed fins in the coanda position. All others are optional versions.

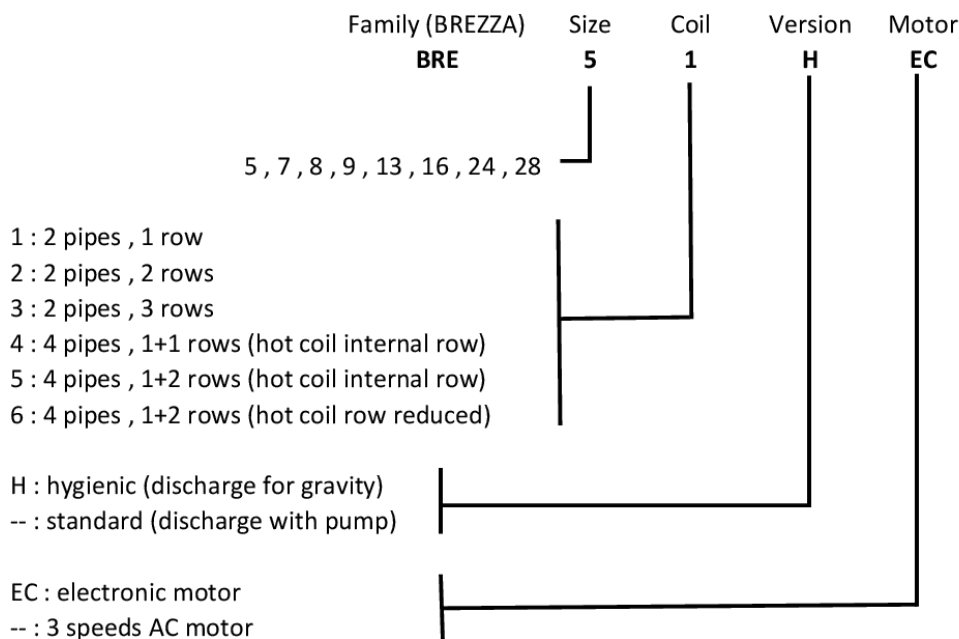

## 5-TECHNICAL SPECIFICATIONS

**FRAME:** made of 1.00 mm thick galvanized sheet steel. This rugged structure prevents the propagation of vibration and comes complete with ceiling fixing brackets.

**FRONT PANEL:** made of 0.8mm thick painted metal plate. The shape of the baffles results in a coanda effect on the output air flow. As an accessory option, it is possible to have adjustable baffles to obtain a coanda effect or vertical air flow (or intermediate positions). The stylish design of the panel integrates perfectly into any environment and type of false ceiling.

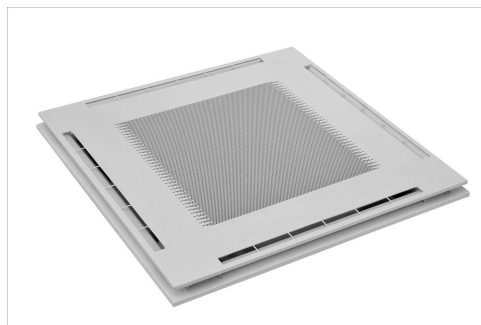

**ACCESSIBILITY:** the filter can be removed without having to use tools. Accessibility to internal components (fan and condensate drain pump) is guaranteed by removing the front panel. The hydraulic connections, the valves and the electrical panel are on the same side and therefore, only one inspection hatch must be made in the false ceiling.

**FILTER:** class G1 (EN779), thickness 6mm, made of polypropylene mesh.

**FAN UNIT:** backward curved blade fan wheels directly coupled to the motor. The fan is made of reinforced plastic (PA6-25GF nylon). The motor and fans are balanced after assembly to ensure vibration free operation. The motor runs on maintenance-free ball bearings.

The AC motor has three speeds, degree of protection IP44, insulation class "B". Built-in thermal cutout.

The EC motor has 0-10V control, protection rating IP54, insulation class "B", emission of disturbances in compliance with EN 61000-6-3 (civil environment), motor and electronics overload cutout, locked rotor protection.

**COIL:** made of diameter 3/8" copper tubing with high efficiency corrugated aluminium fins; manual air bleed valve at the top. Nominal pressure PN10.

**CONDENSATE COLLECTION TRAY:** air conveyor made of foamed polystyrene (PPE) with moulded plastic condensate collection tray, which prevents water leaks even after prolonged use. Drip tray shaped to facilitate run-off, minimising standing water.

**INSULATION:** cassette body insulated with 10mm thick cross-linked polyethylene foam, class B-s2d0 BL-s1d0 according to the EN13501-1 standard. Front panel insulated with 3mm thick polyethylene.

**ELECTRICAL CONTROL PANEL:** made of galvanized sheet steel positioned on the same side as the hydraulic connections.

**CONDENSATE DRAIN PUMP:** centrifugal type, equipped with double level float (alarm and pump on-off) and check valve (to prevent the return of foul smells from the drain and reduce noise on power-on). The maximum head of the pump is 650mm, measured from the edge of the panel.

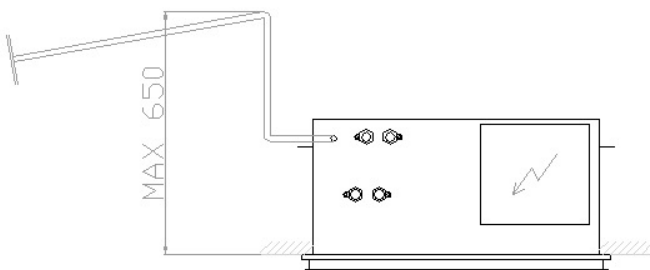

## 6 - TECHNICAL DATA (AC motors)

This chapter lists the operating specifications of the units with 3-row main coils and 1-row auxiliary coils. The main 1- and 2-row coils are also available from our selection software.

### 6.1-Unit with 3-row coil



		2 PIPES									4 PIPES								
		53			73			83			93			75			95		
Speed(E)		min	med	max	min	med	max	min	med	max	min	med	max	min	med	max	min	med	max
Air flow rate	m <sup>3</sup> /h	290	380	550	350	500	710	410	560	770	540	790	920	350	500	710	540	790	920
<b>COOLING - air 27 °C (dry bulb) , 19 °C w.b. - water inlet 7 °C, outlet 12 °C</b>																			
Total capacity (E)	kW	2.25	2.79	3.71	2.62	3.45	4.47	2.97	3.76	4.74	3.66	4.82	5.36	2.18	2.81	3.56	2.96	3.81	4.19
Sensitive capacity (E)	kW	1.58	1.99	2.70	1.86	2.50	3.30	2.12	2.74	3.52	2.66	3.59	4.03	1.60	2.10	2.73	2.23	2.94	3.28
Water flow rate	l/h	387	480	638	450	594	769	510	647	814	629	829	921	375	483	612	509	655	721
Δp (water) (E)	kPa	4.3	6.3	10.3	5.6	9.1	14.3	7.0	10.6	15.9	10.1	16.4	19.7	6.2	9.7	14.6	10.6	16.5	19.5
<b>HEATING - air 20 °C - water inlet 45 °C, outlet 40 °C</b>																			
Capacity (E)	kW	2.17	2.75	3.78	2.56	3.49	4.62	2.94	3.84	4.93	3.72	5.03	5.67	-	-	-	-	-	-
Water flow rate	l/h	375	476	654	443	604	799	509	664	853	644	870	980	-	-	-	-	-	-
Δp (water) (E)	kPa	3.4	5.1	8.9	4.5	7.8	12.7	5.7	9.2	14.2	8.7	14.7	18.2	-	-	-	-	-	-
<b>HEATING - air 20 °C - water inlet 65°C, outlet 55°C</b>																			
Capacity (E)	kW	-	-	-	-	-	-	-	-	-	-	-	-	2.83	3.62	4.61	3.82	4.95	5.47
Water flow rate	l/h	-	-	-	-	-	-	-	-	-	-	-	-	243	312	397	328	425	471
Δp (water) (E)	kPa	-	-	-	-	-	-	-	-	-	-	-	-	5.2	8.1	12.3	8.9	14.0	16.7
<b>MOTOR ELECTRIC POWER DRAW</b>																			
Power draw (E)	W	25	30	40	30	36	50	41	50	64	54	72	87	30	36	50	54	72	87
Max power draw	A	0.18			0.23			0.29			0.40			0.23			0.40		
<b>SOUND DATA</b>																			
Sound power (E)	dB(A)	35	39	48	39	46	55	40	48	57	49	59	62	39	46	55	49	59	62
Sound pressure (*)	dB(A)	26	30	39	30	37	46	31	39	48	40	50	53	30	37	46	40	50	53

(E) = EUROVENT certified performance.

(\*) = the sound pressure levels are lower than power levels by 9 dB(A) for a 100 m<sup>3</sup> space and a reverberation time of 0.5 sec.



## 7 - TECHNICAL DATA (EC motors)

This chapter lists the operating specifications of the units with 3-row main coils and 1-row auxiliary coils. The main 1- and 2-row coils are also available from our selection software.

### 7.1-Unit with 3-row coil



		2 PIPES						4 PIPES					
		73			93			75			95		
Speed(E)		4.7V	6.6V	9.8V	4.0V	6.4V	8.8V	4.7V	6.6V	9.8V	4.0V	6.4V	8.8V
Air flow rate	m <sup>3</sup> /h	300	450	700	350	600	835	300	450	700	350	600	835
<b>COOLING - air 27 °C (dry bulb) , 19 °C w.b. - water inlet 7 °C, outlet 12 °C</b>													
Total capacity (E)	kW	2.25	3.11	4.32	2.55	3.86	4.88	1.90	2.50	3.40	2.10	3.10	3.90
Sensitive capacity (E)	kW	1.59	2.23	3.19	1.81	2.82	3.65	1.40	1.90	2.60	1.60	2.30	3.00
Water flow rate	l/h	397	548	761	450	680	862	327	430	585	361	533	671
Δp (water) (E)	kPa	4.5	7.9	14.1	5.6	11.6	17.5	5.1	8.4	14.0	5.4	12.0	17.9
<b>HEATING - air 20 °C - water inlet 45 °C, outlet 40 °C</b>													
Capacity (E)	kW	2.17	3.11	4.46	2.50	3.93	5.12	-	-	-	-	-	-
Water flow rate	l/h	387	552	790	443	697	909	-	-	-	-	-	-
Δp (water) (E)	kPa	3.5	6.6	12.4	4.5	10.0	15.9	-	-	-	-	-	-
<b>HEATING - air 20 °C - water inlet 65°C, outlet 55°C</b>													
Capacity (E)	kW	-	-	-	-	-	-	2.42	3.22	4.49	2.76	4.03	5.06
Water flow rate	l/h	-	-	-	-	-	-	208	277	386	237	346	435
Δp (water) (E)	kPa	-	-	-	-	-	-	4.3	7.0	11.8	5.2	10.1	14.9
<b>MOTOR ELECTRIC POWER DRAW</b>													
Power draw (E)	W	3	8	22	5	15	48	3	8	22	5	15	48
Max power draw	A	0.17			0.38			0.17			0.38		
<b>SOUND DATA</b>													
Sound power (E)	dB(A)	32	42	53	37	50	59	32	42	53	37	50	59
Sound pressure (*)	dB(A)	23	33	44	28	41	50	23	33	44	28	41	50
<b>ENERGY CLASSIFICATION</b>													
FCEER (E)		A			A			A			A		
FCCOP(E)		A			A			A			A		

(E) = EUROVENT certified performances

(\*) = the sound pressure levels are lower than power levels by 9 dB(A) for a 100 m<sup>3</sup> space and a reverberation time of 0.5 sec.

## 8-DIMENSIONS AND WEIGHTS

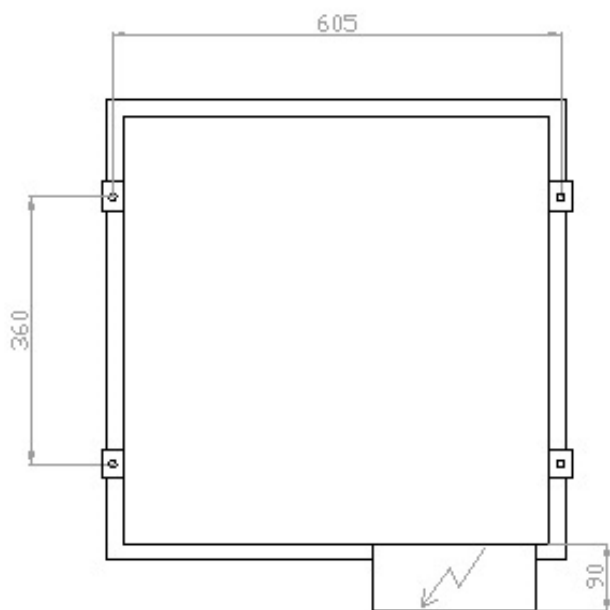
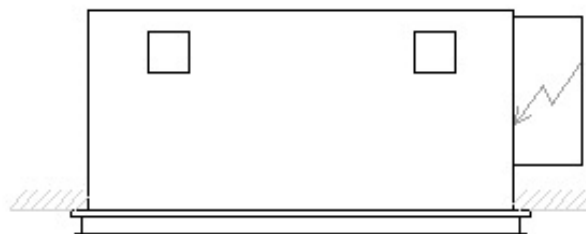
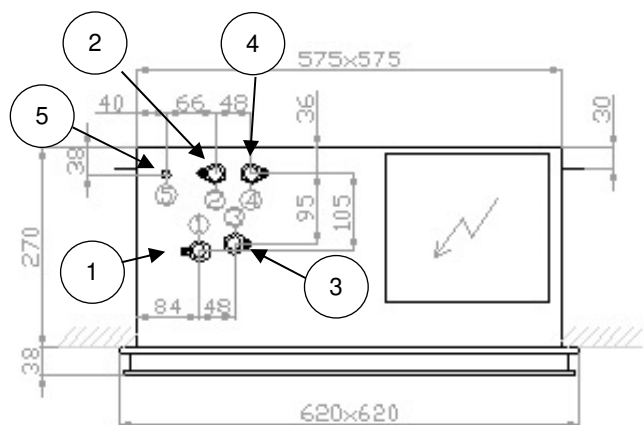

1	Main coil IN	1/2"
2	Main coil OUT	1/2"
3	Auxiliary coil IN	1/2"
4	Auxiliary coil OUT	1/2"
5	Condensate drain	d.12

		51/71	52/72/92	53/73/83/93	74 / 94	75 / 95
<b>Unit weight</b>	<b>kg</b>	27	28	30	28	30
<b>Main coil inside volume</b>	<b>litres</b>	0.6	1.3	2.0	1.4	1.4
<b>Auxiliary coil inside volume</b>	<b>litres</b>	-	-	-	0.6	0.6

## 9-ACCESSORIES

The following accessories are available:

	<b>HYDRAULIC ACCESSORIES</b>	<b>A/K/B</b>
<b>V22</b>	230V 2-way ON-OFF valve	A/K
<b>V42</b>	2-way ON-OFF valve for 4 pipes	A/K
<b>V23</b>	230V 3-way ON-OFF valve	A/K
<b>V43</b>	230V 3-way ON-OFF valve for 4 pipes	A/K
<b>V22M</b>	0-10V 2-way modulating valve	A/K
<b>V42M</b>	0-10V 2-way modulating valve for 4 pipes	A/K
<b>V23M</b>	0-10V 3-way modulating valve	A/K
<b>V43M</b>	0-10V 3-way modulating valve for 4 pipes	A/K
<b>ADPB</b>	Auxiliary condensate collection tray (supplied included in the cassette)	K
<b>PSCC-BI</b>	Auxiliary condensate drain pump	A
	<b>ELECTRICAL ACCESSORIES</b>	
<b>TR24</b>	230Vac-24Vac, 20VA transformer for modulating valve	A
<b>EH</b>	Electric heater with relay and safety thermostat	A
	<b>AERAUIC ACCESSORIES</b>	
<b>FLMA</b>	Flange for ducted air delivery	B
<b>FLAE</b>	Flange for outdoor air intake	B
<b>MECO</b>	Metal cover for exposed installation	K
	<b>OPTIONAL FILTERS</b>	
<b>FA/SAN</b>	Filter with Sanitized treatment	A
<b>FA/H</b>	High efficiency filter PF-ePM10 65% (only for hygienic version H)	K

**A/K/B** : A = accessory supplied mounted on the base unit; K = accessory supplied in a kit (not assembled);

B = accessory supplied assembled, but not mounted on the base unit

## 9.1-Valves (V) and auxiliary tray (ADPB)

Servo-controlled valves should be used to prevent the formation of condensate on the surface of the unit when the fan has stopped.

The valves can be supplied assembled on the unit or as kits (disassembled components).

The condensate collection tray is supplied with the unit as part of the standard equipment, without extra costs (ADPZ).

1. Inlet for 2-pipe systems or cold coil (for 4-pipe system)
2. Outlet for 2-pipe systems or cold coil (for 4-pipe system)
3. Hot/cold valve kit (2 pipes) or Cold valve kit (4 pipes)
4. Hot coil inlet only for 4-pipe system
5. Hot coil outlet only for 4-pipe system
6. Hot valve kit only for 4-pipe system
7. Auxiliary tray

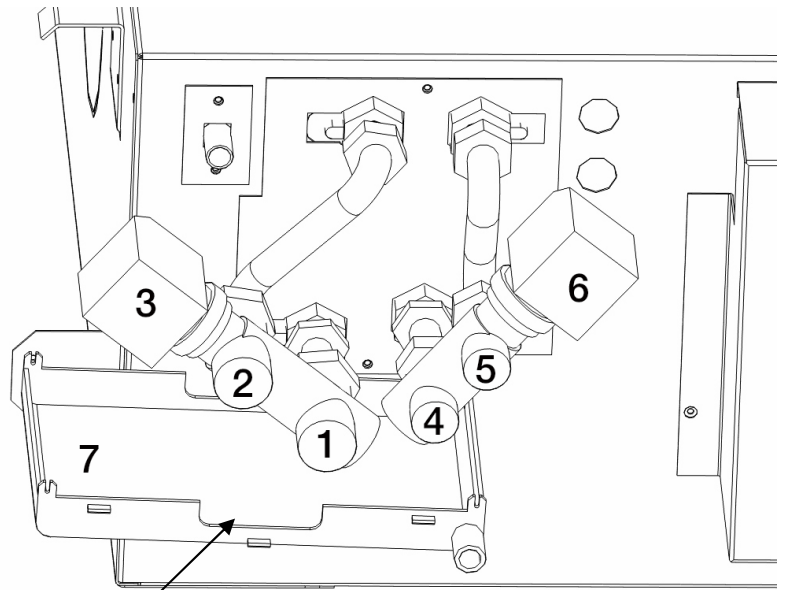

3-way 4-port on/off valve kit

1. Inlet for 2-pipe systems or cold coil (for 4-pipe system)
2. Outlet for 2-pipe systems or cold coil (for 4-pipe system)
3. Hot/cold valve kit (2 pipes) or Cold valve kit (4 pipes)
4. Hot coil inlet only for 4-pipe system
5. Hot coil outlet only for 4-pipe system
6. Hot valve kit only for 4-pipe system
7. Auxiliary tray

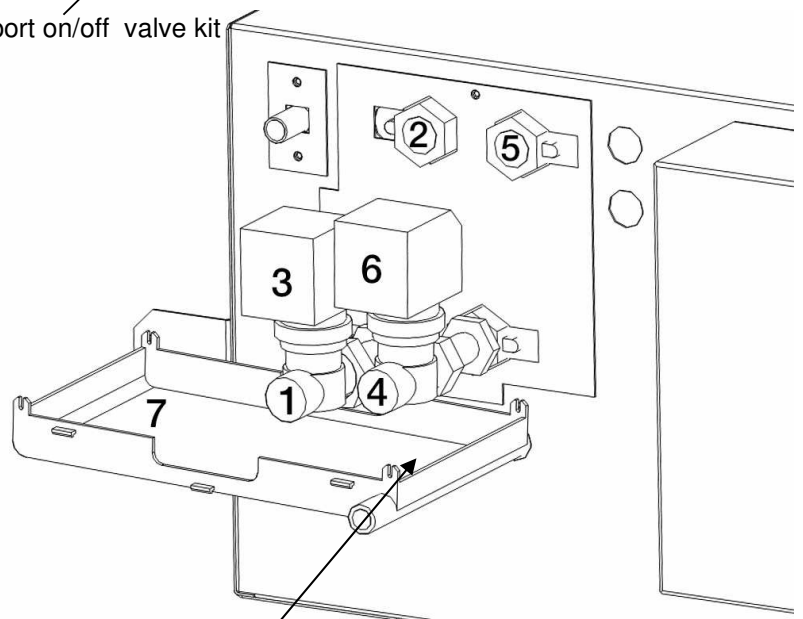

2-way valve kit

VALVES FOR MAIN COIL	51-52-53-71-72-74-75-94	73-83-92-93-95
VALVES FOR AUXILIARY COIL	74-75-94-95	----
<b>GENERAL CHARACTERISTICS</b>		
Connections size	1/2"	3/4"
Kv (2-way valve)	1.7	2.5
Kv (3-way valve, direct flow)	1.7	2.5
Kv (3-way valve, by-pass)	1.2	1.6
Max differential pressure	2.0bar	1.0bar
Nominal pressure	16bar	
Water temperature	4 – 110°C	
<b>ACTUATOR ON/OFF</b>		
Power supply	230V-50Hz (24V-50Hz on request)	
Absorbed power	2.5W	
Stroke time	180s	
Characteristic (valve+actuator)	N.C. (NormallyClosed)	
Protection	IP44	
<b>MODULATING ACTUATOR</b>		
Power supply	24V-50Hz	
Absorbed power	1.5W	
Stroke time	8S	
Control signal	0-10V	
Control signal impedance	100k	
Protection	IP43	

## 9.2-Auxiliary condensate drain pump (PSCC-BI)

The auxiliary condensate drain pump is supplied assembled on the side of the cassette, next to the drain pipe. Therefore, inspection must be provided on this side, too.

Maximum water flow rate	20 l/h
Maximum drainage height	10m (4l/h)
Sound pressure at 1 m	28dB(A)
Power supply	230V – 50/60Hz
Alarm microswitch	NC 8° resistive 250V
Circuit breaker	90°C (automatic reset)
Protection	IP54

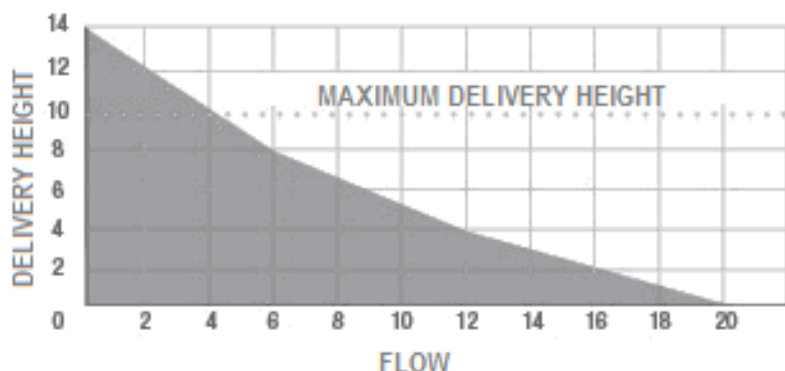

### 9.3-Flange for ducted air delivery (FLMA)

It is possible to connect up to 3 ductable deliveries via d.160 collars. The available head is a function of the number of collars connected and the air flow. The positions of the collars are shown in the figure below.

### 9.4-Flange for outdoor air intake (FLAE)

It is possible to connect an outdoor air intake through a d.100 collar. The maximum outdoor air flow is 100cu.m/h. The outside air must be treated, filtered and must not be at low temperature.

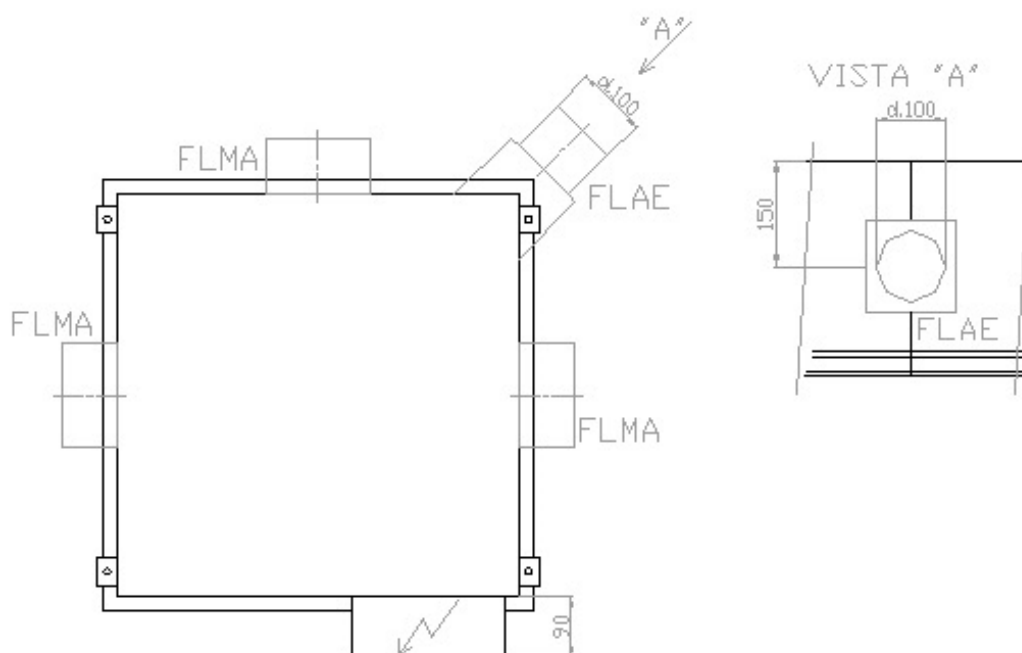
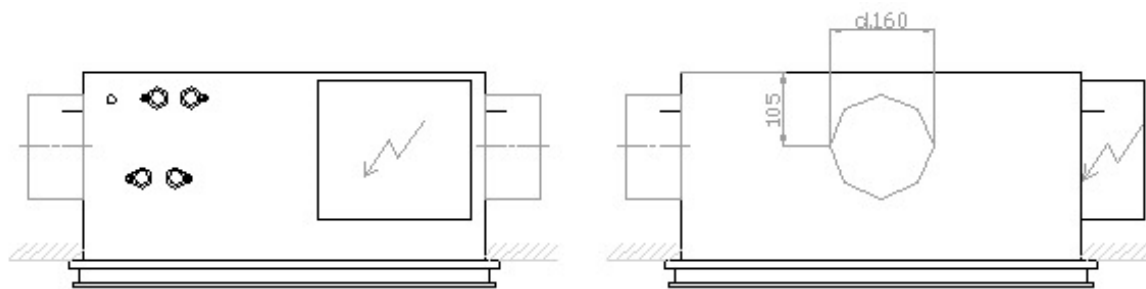

### 9.5 - Metal cover for exposed installation (MECO)

The MECO accessory allows an exposed cassette to be installed when there is no false ceiling or when the existing false ceiling height is insufficient to contain it. It is made of painted sheet metal and its installation is harmonised with the cassette and its panel. The cover on the hydraulic and electrical connections side is easily removable to facilitate maintenance of the electrical panel and valves.

Two variants are available: one pre-set for hydraulic connections coming from above (vertical) and one coming from the side (horizontal) just below the ceiling. If valves are also ordered, specific kits must be ordered, optimised to facilitate installation, which, for horizontal versions, include flexible hoses and manual ball valves.

#### Coil connections

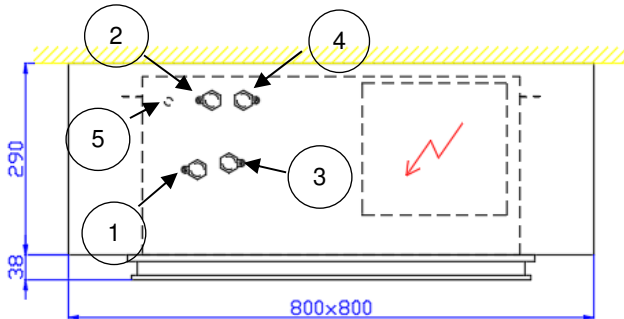

1	Main coil IN
2	Main coil OUT
3	Auxiliary coil IN
4	Auxiliary coil OUT
5	Condensate drain (d. 12)

3-way valve connections 4 on-off ports (vertical)

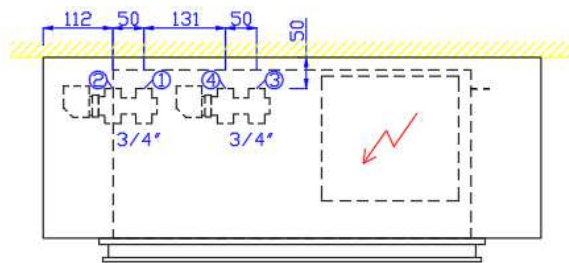

2-way valve connections (vertical)

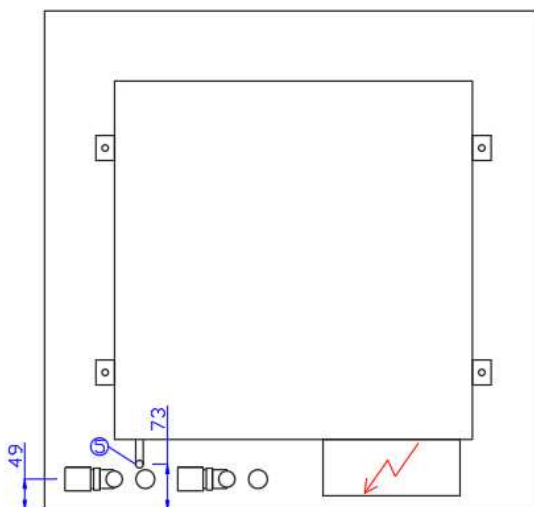
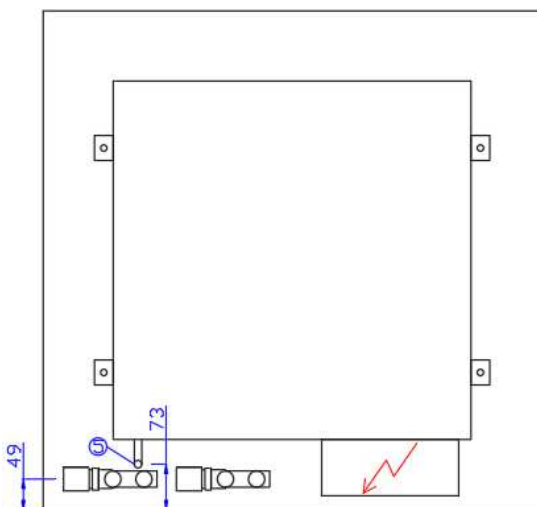
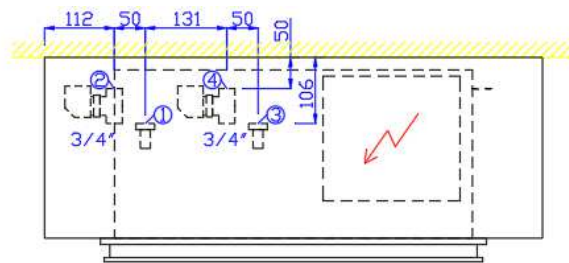

3-way valve connections 4 on-off ports (horizontal)

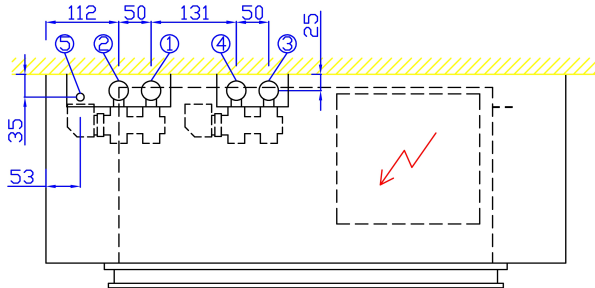

2-way valve connections (horizontal)

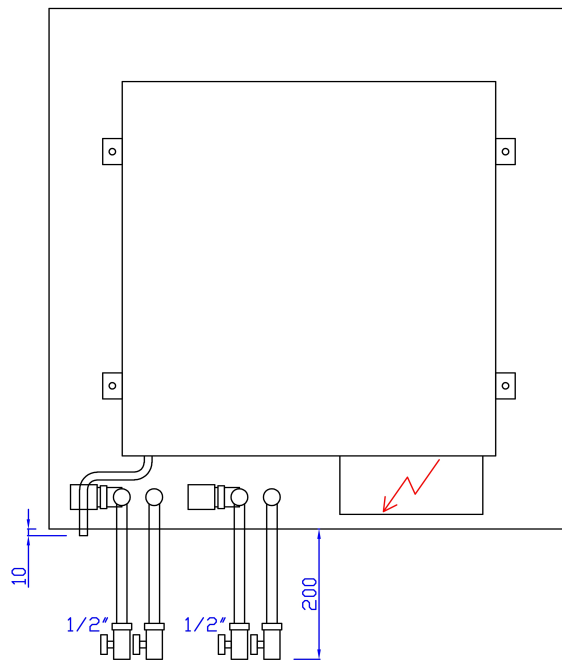
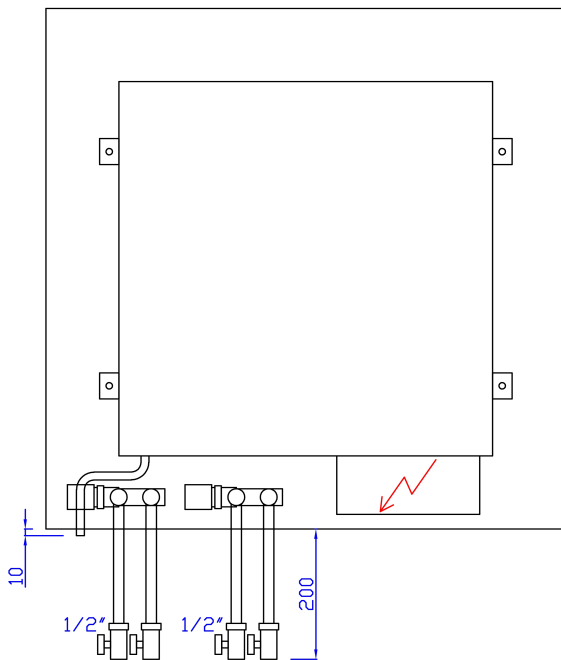
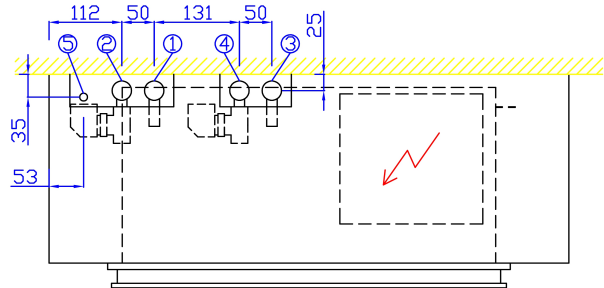

COVER CODE	DESCRIPTION	VALVE KIT CODE (*)
MECO-BRE51/93S 81	For horizontal connections - 2 pipes	Valve code + "BRE51/93S 81"
MECO-BRE74/95S 81	For horizontal connections - 4 pipes	Valve code + "BRE74/95S 81"
MECO-BRE51/95S 92	For vertical connections - 2/4 pipes	Valve code + "BRE51/93S 26" for 2 pipes Valve code + "BRE74/95S 26" for 4 pipes

(\*) ON/OFF valves (for 2 and 4 pipes) or modulating valves (only for 2 pipes) can be installed inside the MECO. It is not possible to install modulating valves for 4 pipes.



### 9.6-Filter with Sanitized treatment (FA/SAN)

Filter in synthetic material with support in galvanised steel and double galvanised mesh, thickness 6mm. The special FiltraSan treatment, developed in collaboration with Sanitized, certifies the non-proliferation of mould and bacteria:

- Staphylococcus aureus reduction: >99,99% according to JIS L 1902
- fungal growth rate: none according to EN ISO 846

The complete test reports and certifications can be obtained from our Sales department.

### 9.7-High efficiency filter (FA/H)

Filter in synthetic material, total thickness 130mm and class PF-ePM10 65%. Given its considerable size, it can be installed only in the hygienic version cassette (H). The pressure drop due to the high filtration class results in a decrease in the cassette efficiency by about 10% (with clean filter) compared to its rated performance. We also recommend using the standard filter as a pre-filter, otherwise the FA/H filter could clog very quickly.

### 9.8-Electrical heater (EH)

Armoured electrical heater, inserted inside the coil pack, available with 3-row, 2 pipe coils. The heater must be factory-installed, it cannot be ordered as an extra accessory to be retrofitted. The heater control relay and two safety thermostats are included (one manual resetting and one automatic resetting types). The presence of the electric heater inside the coil implies a decrease of about 5% of the rated cooling capacity.

	<b>53</b>	<b>73-83-93</b>
Heater power (W)	1500	3000W
Power supply	230V-1ph-50Hz	

## 10-Hygienic version

The hygienic version differs from the standard version due to the absence of the condensate drain pump. Draining is achieved by gravity, so in order to have the required difference in height, the overall height of the cassette is greater.

This version is recommended in environments characterised by:

- Less frequent maintenance (banks, police offices, ...): services due to pump or pump float faults are no longer required
- Increased hygiene requirements (hospitals, health care facilities ...): water stagnation inside the tank is reduced, consequently, the chances of bacteria or mould growth are reduced.
- Silent environment requirements (libraries, ...): the (however limited) condensate drain pump operating noise is eliminated.

NEW WATER CASSETTE- TECHNICAL MANUAL

For a better level of hygiene, we recommend using the optional FA/SAN and/or FA/H filter cassette (see the specific paragraph)

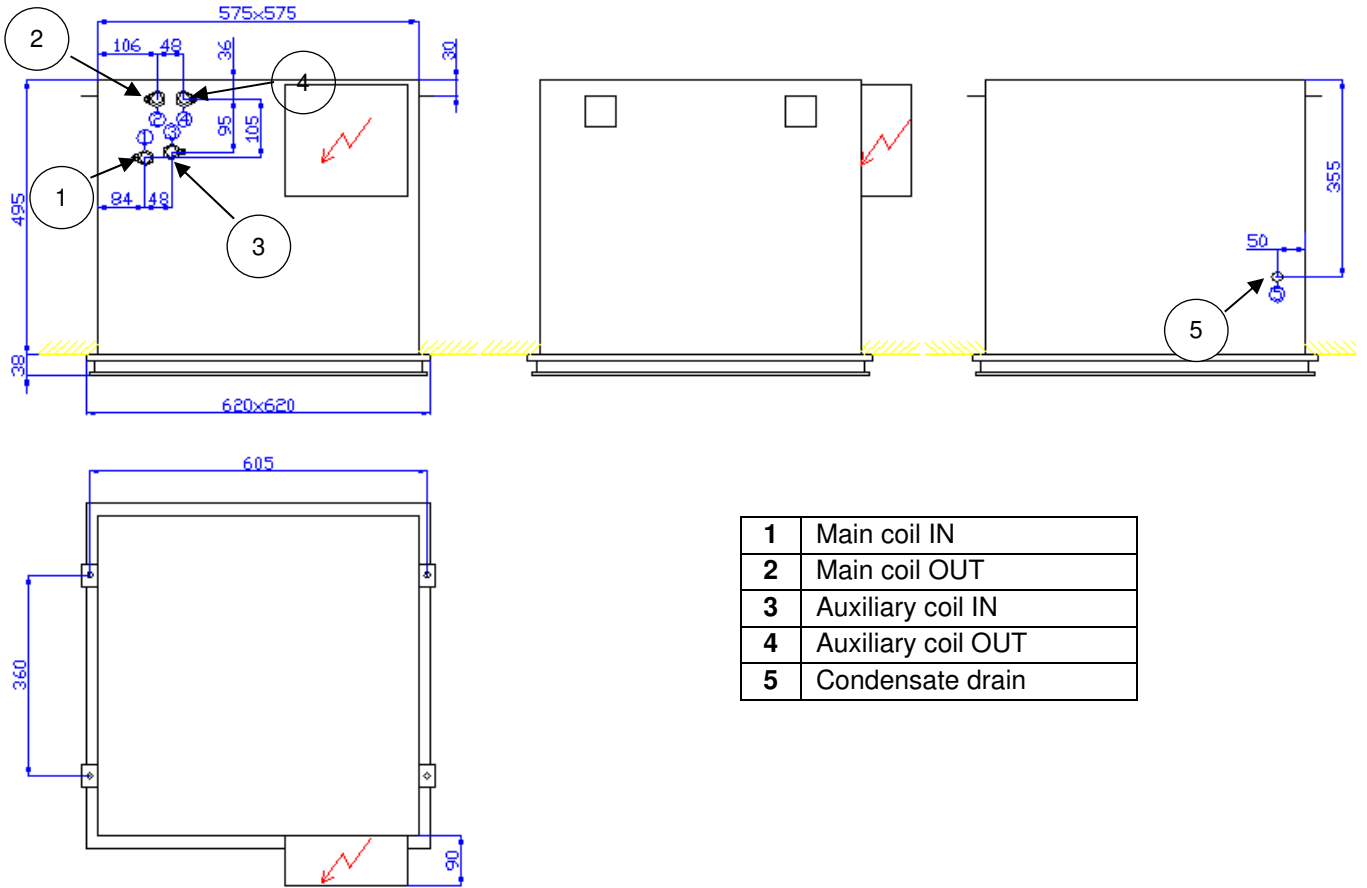

## 11-Electrical connections

### 11.1-Wiring diagram of cassette with AC motor

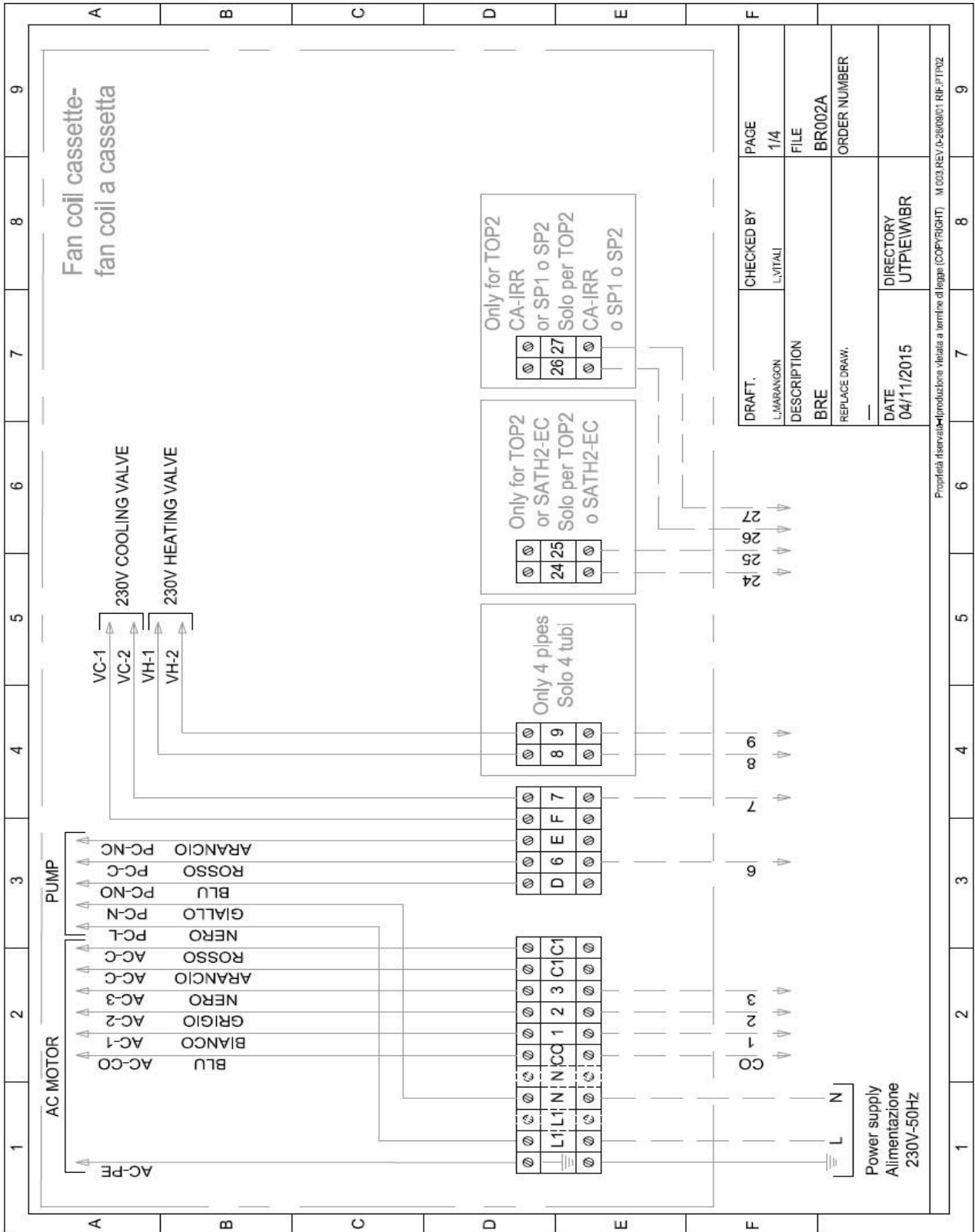

11.2-Wiring diagram of cassette with EC motor

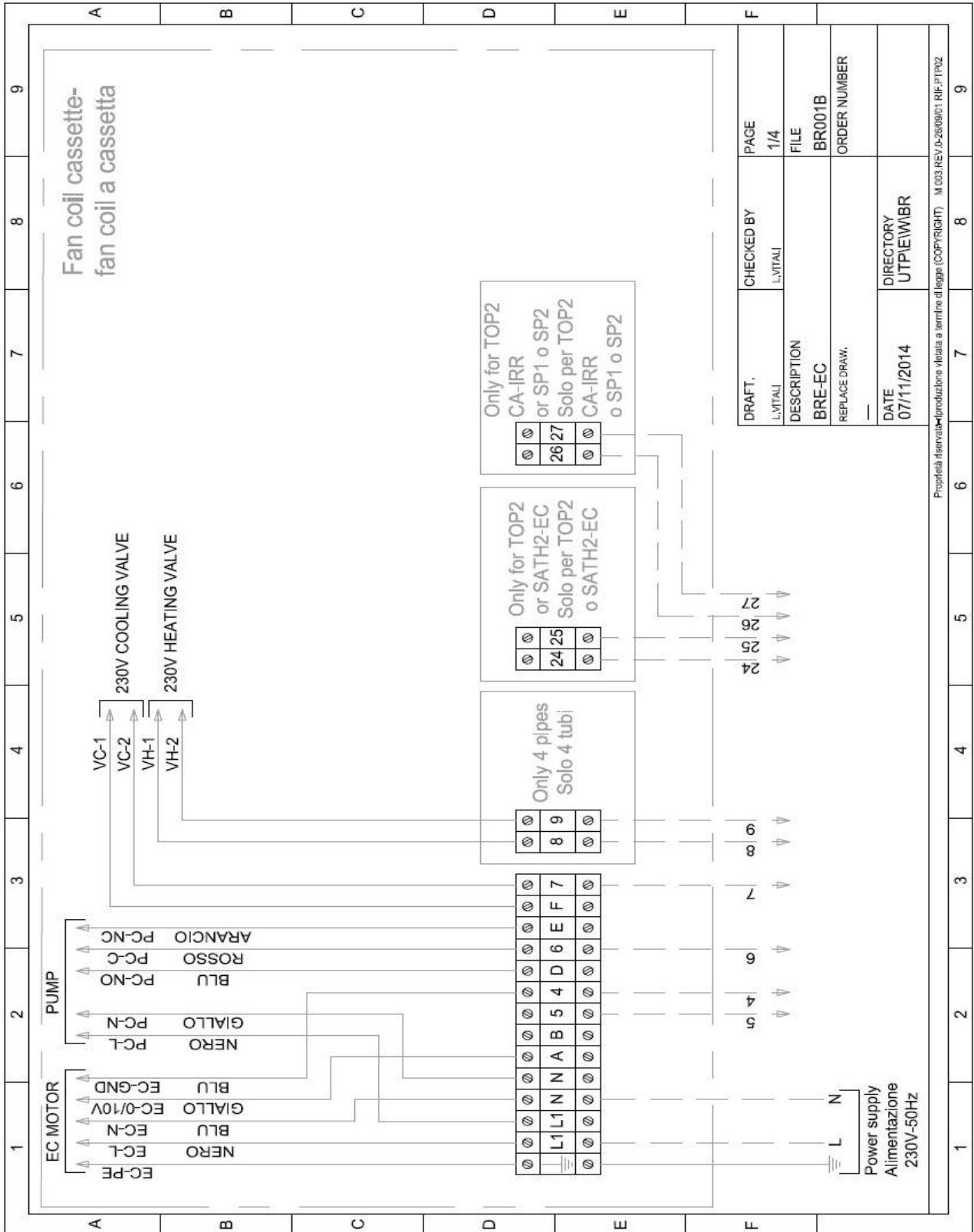

EXTERNAL THERMOSTAT CONTROLS	
CO	Fan common wire (neutral)
1	Minimum fan speed (line)
2	Medium fan speed (line)
3	Maximum fan speed (line)
4	Reference for 0-10V signal
5	0-10V signal for motor control
6	Common 2-pipe valve / 4-pipe cold valve (neutral)
7	2-pipe valve signal / 4-pipe cold valve (line)
8	Common 4-pipe hot valve (neutral) - only if available
9	4-pipe hot valve signal (line) - only if available
24-25	NTC water probe - only if available
26-27	NTC remote air probe - only if available





something different

