

# USER'S MANUAL

## Split Air Conditioner

**MODEL:**

**SMVH09B-2A2A3NG(O) SMVH09B-2A2A3NH(O)**

**SMVH12B-3A2A3NG(O) SMVH12B-2A2A3NH(O)**

**SMVH18B-4A2A3NG(O)**

**SMVH24B-5A2A3NG(O)**



# Content

## Operation Notices

Precautions .....	1
Parts name.....	6

## Malfunction

Malfunction analysis.....	7
---------------------------	---

## Installation Notice

Safety operation of flammable refrigerant.....	8
Installation prepare.....	10

## Installation

Installation of outdoor unit.....	14
Check after installation .....	17
Test operation.....	17

## Attachment

Configuration of connection pipe.....	18
Pipe expanding method.....	19

If it needs to install, move or maintain the air conditioner, please contact dealer or local service center to conduct it at first. Air conditioner must be installed, moved or maintained by appointed unit. Otherwise, it may cause serious damage or personal injury or death.



This marking indicates that this product should not be disposed with other household wastes throughout the EU. To prevent possible harm to the environment or human health from uncontrolled waste disposal, recycle it responsibly to promote the sustainable reuse of material resources. To return your used device, please use the return and collection systems or contact the retailer where the product was purchased. They can take this product for environmental safe recycling.

**R32:675**

# Precautions

Please read this operating manual carefully before operating the unit.



Appliance filled with flammable gas R32.



Before use the appliance, read the owner's manual first.



Before install the appliance, read the installation manual first.



Before repair the appliance, read the service manual first.

The figures in this manual may be different with the material objects, please refer to the material objects for reference.

## The Refrigerant

To realize the function of the air conditioner unit, a special refrigerant circulates in the system. The used refrigerant is the fluoride R32, which is specially cleaned. The refrigerant is flammable and inodorous. Furthermore, it can lead to explosion under certain conditions. But the flammability of the refrigerant is very low. It can be ignited only by fire.

Compared to common refrigerants, R32 is a nonpolluting refrigerant with no harm to the ozone layer. The influence upon the greenhouse effect is also lower. R32 has got very good thermodynamic features which lead to a really high energy efficiency. The units therefore need a less filling.

### WARNING:

Do not use means to accelerate the defrosting process or to clean, other than those recommended by the manufacturer. Should repair be necessary, contact your nearest authorized Service Center.

Any repairs carried out by unqualified personnel may be dangerous.

The appliance shall be stored in a room without continuously operating ignition sources.

(For example: open flames, an operating gas appliance or an operating electric heater.)

Do not pierce or burn.

Appliance shall be installed, operated and stored in a room with a floor area larger than "X"m<sup>2</sup> (see table 1). (only applies to appliances that are not fixed appliances)

Appliance filled with flammable gas R32. For repairs, strictly follow manufacturer's instructions only.

Be aware that refrigerants do not contain odour.

Read specialist's manual.

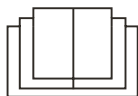

# Precautions



WARNING

## Operation and Maintenance

This appliance can be used by children aged of 8 years and above and persons with reduced physical, sensory or mental capabilities or lack of experience and knowledge if they have been given supervision or instruction concerning use of the appliance in a safe way and understand the hazards involved.

Children shall not play with the appliance.

Cleaning and user maintenance shall not be made by children without supervision.

Do not connect air conditioner to multi-purpose socket. Otherwise, it may cause fire hazard.

Do disconnect power supply when cleaning air conditioner. Otherwise, it may cause electric shock.

If the supply cord is damaged, it must be replaced by the manufacturer, its service agent or similarly qualified persons in order to avoid a hazard.

Do not wash the air conditioner with water to avoid electric shock.

Do not spray water on indoor unit. It may cause electric shock or malfunction.

After removing the filter, do not touch fins to avoid injury.

Do not use fire or hair dryer to dry the filter to avoid deformation or fire hazard.

Maintenance must be performed by qualified professionals. Otherwise, it may cause personal injury or damage.

Do not repair air conditioner by yourself. It may cause electric shock or damage. Please contact dealer when you need to repair air conditioner.

Do not extend fingers or objects into air inlet or air outlet. It may cause personal injury or damage.

# Precautions



## WARNING

**Do not block air outlet or air inlet. It may cause malfunction.**

**Do not spill water on the remote controller, otherwise the remote controller may be broken.**

**When below phenomenon occurs, please turn off air conditioner and disconnect power immediately, and then contact the dealer or qualified professionals for service.**

- Power cord is overheating or damaged.
- There's abnormal sound during operation.
- Circuit break trips off frequently.
- Air conditioner gives off burning smell.
- Indoor unit is leaking.

**If the air conditioner operates under abnormal conditions, it may cause malfunction, electric shock or fire hazard.**

**When turning on or turning off the unit by emergency operation switch, please press this switch with an insulating object other than metal.**

**Do not step on top panel of outdoor unit, or put heavy objects. It may cause damage or personal injury.**

### Attachment

**Installation must be performed by qualified professionals. Otherwise, it may cause personal injury or damage.**

**Must follow the electric safety regulations when installing the unit.**

**According to the local safety regulations, use qualified power supply circuit and circuit break.**

**Do install the circuit break. If not, it may cause malfunction.**

**An all-pole disconnection switch having a contact separation of at least 3mm in all poles should be connected in fixed wiring.**

**Air Conditioner should be properly grounded. Incorrect grounding may cause electric shock.**

# Precautions



## WARNING

Including an circuit break with suitable capacity, please note the following table. Air switch should be included magnet buckle and heating buckle function, it can protect the circuit-short and overload.

**Don't use unqualified power cord.**

**Make sure the power supply matches with the requirement of air conditioner. Unstable power supply or incorrect wiring or malfunction. Please install proper power supply cables before using the air conditioner.**

**Properly connect the live wire, neutral wire and grounding wire of power socket.**

**Be sure to cut off the power supply before proceeding any work related to electricity and safety.**

**Do not put through the power before finishing installation.**

**If the supply cord is damaged, it must be replaced by the manufacturer, its service agent or similarly qualified persons in order to avoid a hazard.**

**The temperature of refrigerant circuit will be high, please keep the interconnection cable away from the copper tube.**

**The appliance shall be installed in accordance with national wiring regulations.**

**Installation must be performed in accordance with the requirement of NEC and CEC by authorized personnel only.**

**The air conditioner is the first class electric appliance. It must be properly grounding with specialized grounding device by a professional. Please make sure it is always grounded effectively, otherwise it may cause electric shock.**

**The yellow-green wire in air conditioner is grounding wire, which can't be used for other purposes.**

**The grounding resistance should comply with national electric safety regulations.**

# Precautions



## WARNING

The appliance must be positioned so that the plug is accessible.

All wires of indoor unit and outdoor unit should be connected by a professional.

If the length of power connection wire is insufficient, please contact the supplier for a new one. Avoid extending the wire by yourself.

For the air conditioner with plug, the plug should be reachable after finishing installation.

For the air conditioner without plug, an circuit break must be installed in the line.

If you need to relocate the air conditioner to another place, only the qualified person can perform the work. Otherwise, it may cause personal injury or damage.

Select a location which is out of reach for children and far away from animals or plants. If it is unavoidable, please add the fence for safety purpose.

The indoor unit should be installed close to the wall.

## Working temperature range

	Indoor side DB/WB(°C)	Outdoor side DB/WB(°C)
Maximum cooling	32/23	43/26
Maximum heating	27/-	24/18

### **NOTE:**

The operating temperature range (outdoor temperature) for cooling is 18 °C ~43 °C ; Heating temperature range for the model without electric heating belt for chassis is -15 °C ~ 24 °C ; Heating temperature range for the model with electric heating belt for chassis is -20 °C ~24 °C .

# Parts name

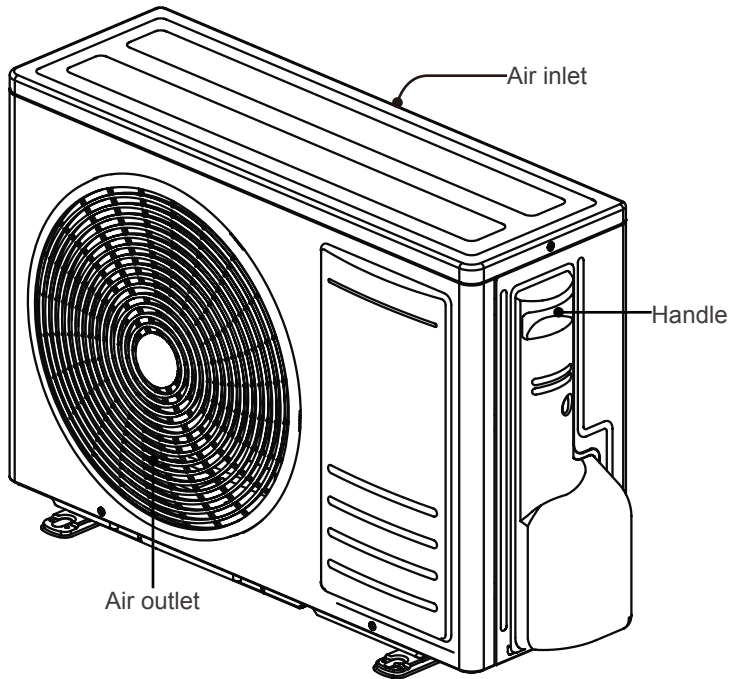

**NOTE:**

Actual product may be different from above graphics, please refer to actual products.



# Malfunction analysis

## General phenomenon analysis

Please check below items before asking for maintenance. If the malfunction still can't be eliminated, please contact local dealer or qualified professionals.

Phenomenon	Check items	Solution
Air conditioner can't operate	Power failure?	Wait until power recovery.
	Is plug loose?	Reinsert the plug.
	Circuit break trips off or fuse is burnt out?	Ask professional to replace circuit break or fuse.
	Wiring has malfunction?	Ask professional to replace it
	Unit has restarted immediately after stopping operation?	Wait for 3min, and then turn on the unit again.
	Whether the function setting for remote controller is correct?	Reset the function.
Set temperature can't be adjusted	Unit is operating under auto mode?	Temperature can't be adjusted under auto mode. Please switch the operation mode if you need to adjust temperature.
	Your required temperature exceeds the set temperature range?	Set temperature range: 16°C~31°C
Cooling (heating) effect is not good.	Voltage is too low?	Wait until the voltage resumes normal.
	Filter is dirty?	Clean the filter.
	Set temperature is in proper range?	Adjust temperature to proper range.
	Door and window are open?	Close door and window.
Air conditioner operates normally suddenly	Whether there's interference, such as thunder, wireless devices, etc.	Disconnect power, put back power, and then turn on the unit again.
Outdoor unit has vapor	Heating mode is turned on?	During defrosting under heating mode, it may generate vapor, which is a normal phenomenon.
"Water flowing" noise	Air conditioner is turned on or turned off just now?	The noise is the sound of refrigerant flowing inside the unit, which is a normal phenomenon.
Cracking noise	Air conditioner is turned on or turned off just now?	This is the sound of friction caused by expansion and/or contraction of panel or other parts due to the change of temperature.

# Safety operation of flammable refrigerant

## Qualification requirement for installation and maintenance man

All the work men who are engaging in the refrigeration system should bear the valid certification awarded by the authoritative organization and the qualification for dealing with the refrigeration system recognized by this industry. If it needs other technician to maintain and repair the appliance, they should be supervised by the person who bears the qualification for using the flammable refrigerant. It can only be repaired by the method suggested by the equipment's manufacturer.

## Installation notes

1. The air conditioner is not allowed to use in a room that has running fire (such as fire source, working coal gas ware, operating heater).
2. It is not allowed to drill hole or burn the connection pipe.
3. The air conditioner must be installed in a room that is larger than the minimum room area. The minimum room area is shown on the nameplate or following table 1.
4. Leak test is a must after installation.

Table 1: Minimum room area (m<sup>2</sup>)

Minimum room area (m <sup>2</sup> )	Charge amount (kg)	≤1.2	1.3	1.4	1.5	1.6	1.7	1.8	1.9	2.0	2.1	2.2	2.3	2.4	2.5
	floor location	/	14.5	16.8	19.3	22.0	24.8	27.8	31.0	34.4	37.8	41.5	45.4	49.4	53.6
window mounted	/	5.2	6.1	7.0	7.9	8.9	10.0	11.2	12.4	13.6	15	16.3	17.8	19.3	
wall mounted	/	1.6	1.9	2.1	2.4	2.8	3.1	3.4	3.8	4.2	4.6	5	5.5	6.0	
ceiling mounted	/	1.1	1.3	1.4	1.6	1.8	2.1	2.3	2.6	2.8	3.1	3.4	3.7	4.0	

## Maintenance notes

**Check whether the maintenance area or the room area meet the requirement of the nameplate.**

— It's only allowed to be operated in the rooms that meet the requirement of the nameplate.

**Check whether the maintenance area is well-ventilated.**

— The continuous ventilation status should be kept during the operation process.

**Check whether there is fire source or potential fire source in the maintenance area.**

— The naked flame is prohibited in the maintenance area; and the "no smoking" warning board should be hanged.

**Check whether the appliance mark is in good condition.**

— Replace the vague or damaged warning mark.

# Safety operation of flammable refrigerant

## Welding

If you should cut or weld the refrigerant system pipes in the process of maintaining, please follow the steps as below:

1. Shut down the unit and cut power supply.
  2. Eliminate the refrigerant.
  3. Vacuuming.
  4. Clean it with N2 gas.
  5. Cutting or welding.
  6. Carry back to the service spot for welding.
- The refrigerant should be recycled into the specialized storage tank.

Make sure that there isn't any naked flame near the outlet of the vacuum pump and it's well-ventilated.

## Filling the refrigerant

1. Use the refrigerant filling appliances specialized for R32. Make sure that different kinds of refrigerant won't contaminate with each other.
2. The refrigerant tank should be kept upright at the time of filling refrigerant.
3. Stick the label on the system after filling is finished (or haven't finished).
4. Don't overfilling.
5. After filling is finished, please do the leakage detection before test running; another time of leak detection should be done when it's removed.

## Safety instructions for transportation and storage

1. Please use the flammable gas detector to check before unload and open the container.
2. No fire source and smoking.
3. According to the local rules and laws.

# Installation prepare

## Installation drawing

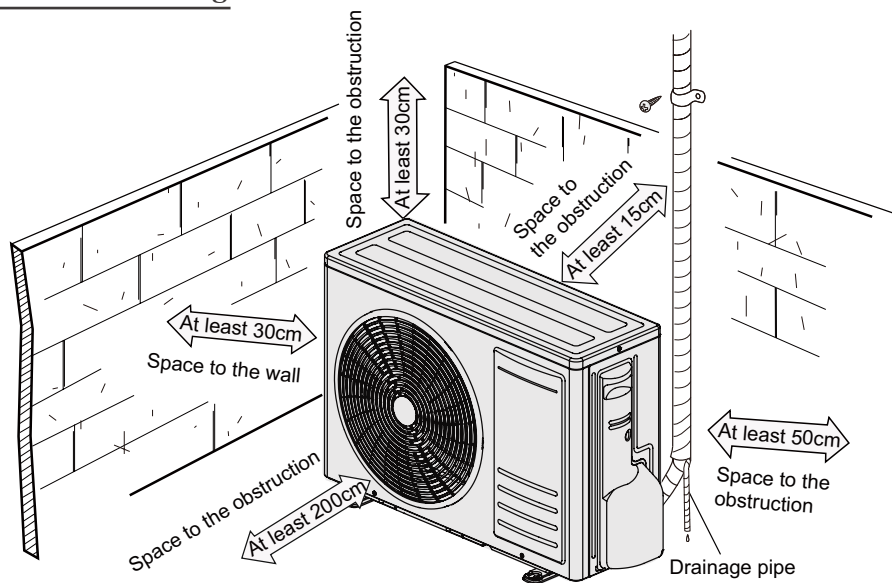

## Tools

1 Level meter	2 Screw driver	3 Impact drill
4 Drill head	5 Pipe expander	6 Torque wrench
7 Open-end wrench	8 Pipe cutter	9 Leakage detector
10 Vacuum pump	11 Pressure meter	12 Universal meter
13 Inner hexagon spanner		14 Measuring tape

## Selection of location

### **Basic requirement**

Installing the unit in the following places may cause malfunction. If it is unavoidable, please consult the local dealer:

1. The place with strong heat sources, vapors, flammable or explosive gas, or volatile objects spread in the air.
2. The place with high-frequency devices (such as welding machine, medical equipment).
3. The place near coast area.
4. The place with oil or fumes in the air.
5. The place with sulfured gas.
6. Other places with special circumstances.
7. The appliance shall not be installed in the laundry.

# Installation prepare

## Outdoor unit

1. Select a location where the noise and out flow air emitted by the outdoor unit will not affect neighborhood.
2. The location should be well ventilated and dry, in which the outdoor unit won't be exposed directly to sunlight or strong wind.
3. The location should be able to withstand the weight of outdoor unit.
4. Make sure that the installation follows the requirement of installation dimension diagram.
5. Select a location which is out of reach for children and far away from animals or plants. If it is unavoidable, please add the fence for safety purpose.

## Safety precaution

1. Must follow the electric safety regulations when installing the unit.
2. According to the local safety regulations, use qualified power supply circuit and circuit break.
3. Make sure the power supply matches with the requirement of air conditioner. Unstable power supply or incorrect wiring or malfunction. Please install proper power supply cables before using the air conditioner.
4. Properly connect the live wire, neutral wire and grounding wire of power socket.
5. Be sure to cut off the power supply before proceeding any work related to electricity and safety.
6. Do not connect the power before finishing installation.
7. If the supply cord is damaged, it must be replaced by the manufacturer, its service agent or similarly qualified persons in order to avoid a hazard.
8. The temperature of refrigerant circuit will be high, please keep the interconnection cable away from the copper tube.
9. The appliance shall be installed in accordance with national wiring regulations.
10. Installation must be performed in accordance with the requirement of NEC and CEC by authorized personnel only.
11. Appliance shall be installed, operated and stored in a room with a floor area larger than "X"m<sup>2</sup> (see table 1).



Please notice that the unit is filled with flammable gas R32. Inappropriate treatment of the unit involves the risk of severe damages of people and material. Details to this refrigerant are found in chapter "refrigerant".

# Installation prepare

## Grounding requirement

1. The air conditioner is the first class electric appliance. It must be properly grounding with specialized grounding device by a professional. Please make sure it is always grounded effectively, otherwise it may cause electric shock.
2. The yellow-green wire in air conditioner is grounding wire, which can't be used for other purposes.
3. The grounding resistance should comply with national electric safety regulations.
4. The appliance must be positioned so that the plug is accessible.
5. An all-pole disconnection switch having a contact separation of at least 3mm in all poles should be connected in fixed wiring. For models with a power plug, make sure the plug is within reach after installation.
6. Including an circuit break with suitable capacity, please note the following table. Circuit break should be included magnet buckle and heating buckle function, it can protect the circuit-short and overload. (Caution: please do not use the fuse only for protect the circuit)

Air-conditioner	Circuit break capacity	Minimum Sectional Area of Power Cable (mm <sup>2</sup> )
09K、12K	10A	3G1.0
18K	16A	3G1.5
24K	25A	3G2.5

## Safety precautions for installing and relocating the unit

To ensure safety, please be mindful of the following precautions.



### WARNING

- 1. When installing or relocating the unit, be sure to keep the refrigerant circuit free from air or substances other than the specified refrigerant.**
  - Any presence of air or other foreign substance in the refrigerant circuit will cause system pressure rise or compressor rupture, resulting in injury.
- 2. When installing or moving this unit, do not charge the refrigerant which is not comply with that on the nameplate or unqualified refrigerant.**
  - Otherwise, it may cause abnormal operation, wrong action, mechanical malfunction or even series safety accident.
- 3. When refrigerant needs to be recovered during relocating or repairing the unit, be sure that the unit is running in cooling mode. Then, fully close the valve at high pressure side (liquid valve). About 30-40 seconds later, fully close the valve at low**

# Installation prepare

**pressure side (gas valve), immediately stop the unit and disconnect power. Please note that the time for refrigerant recovery should not exceed 1 minute.**

- If refrigerant recovery takes too much time, air may be sucked in and cause pressure rise or compressor rupture, resulting in injury.
- 4. During refrigerant recovery, make sure that liquid valve and gas valve are fully closed and power is disconnected before detaching the connection pipe.**
    - If compressor starts running when stop valve is open and connection pipe is not yet connected, air will be sucked in and cause pressure rise or compressor rupture, resulting in injury.
  - 5. When installing the unit, make sure that connection pipe is securely connected before the compressor starts running.**
    - If compressor starts running when stop valve is open and connection pipe is not yet connected, air will be sucked in and cause pressure rise or compressor rupture, resulting in injury.
  - 6. Prohibit installing the unit at the place where there may be leaked corrosive gas or flammable gas.**
    - If there leaked gas around the unit, it may cause explosion and other accidents.
  - 7. Do not use extension cords for electrical connections. If the electric wire is not long enough, please contact a local service center authorized and ask for a proper electric wire.**
    - Poor connections may lead to electric shock or fire.
  - 8. Use the specified types of wires for electrical connections between the indoor and outdoor units. Firmly clamp the wires so that their terminals receive no external stresses.**
    - Electric wires with insufficient capacity, wrong wire connections and insecure wire terminals may cause electric shock or fire.

# Installation of outdoor unit

## Step 1: Fix the support of outdoor

Select it according to the actual installation situation

1. Select installation location according to the house structure.
2. Fix the support of outdoor unit on the selected location with expansion screws.

### *Note:*

- Take sufficient protective measures when installing the outdoor unit.
- Make sure the support can withstand at least four times of the unit weight.
- The outdoor unit should be installed at least 3cm above the the floor in order to install drainjoint.
- For the unit with cooling capacity of 2300W~5000W, 6 expansion screws are needed; for the unit with cooling capacity of 6000W~8000W, 8 expansion screws are needed; for the unit with cooling capacity of 10000W ~16000W, 10 expansion screws are needed.

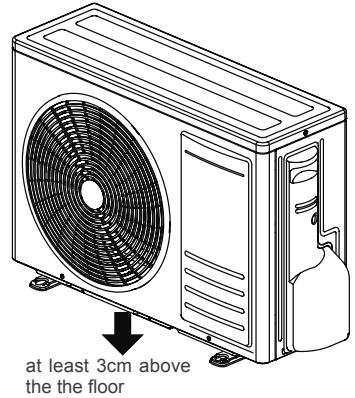

## Step 2: Install drain joint and chasis rubber plug

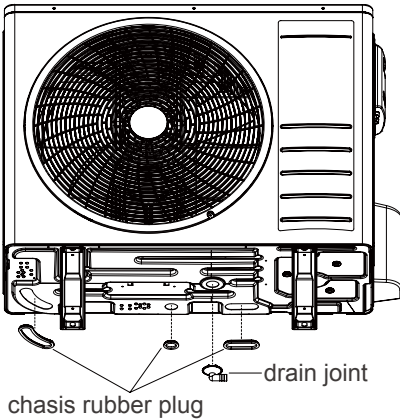

1. Connect the outdoor drain joint into the hole on the chassis, as shown in the picture below.
2. Connect the drain hose into the drain vent.
3. For chasis electric heater equipped unit, there are several drain holes on the chassis, which is used for quick drainage to avoid chasis freeze in cold area. If there is no need for quick drainage, please fix the rubber plug into chassis. According to drain hole shape, select corresponding plug to fix into holes from the bottom, shown as the left.

### *Note:*

There is no drain joint and chasis rubber plug for some unit, please refer to accessory package.

## Step 3: Fix outdoor unit

1. Place the outdoor unit on the support.
2. Fix the foot holes of outdoor unit with bolts.

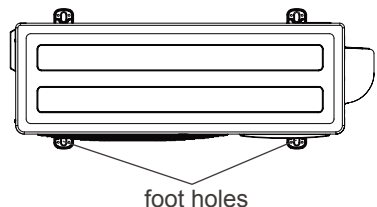



# Installation of outdoor unit

## Step 4: Connect indoor and outdoor pipe

1. Remove the screw on the right handle of outdoor unit and then remove the handle.

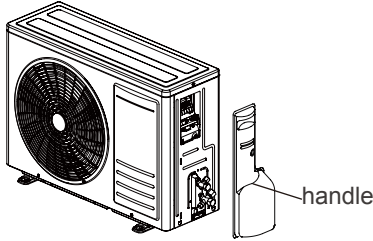

2. Remove the screw cap of valve and aim the pipe joint at the bellmouth of pipe.

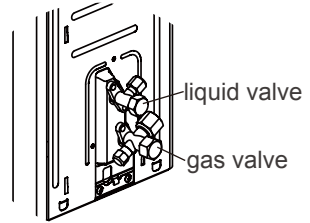

3. Pretightening the union nut with hand.

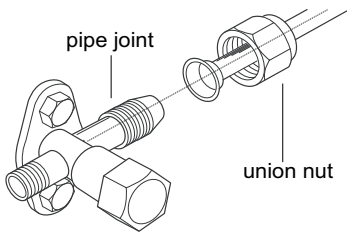

4. Tighten the union nut with torque wrench by referring to the sheet below.

Hex nut diameter	Tightening torque (N·m)
Φ 6	15~20
Φ 9.52	30~40
Φ 12	45~55
Φ 16	60~65
Φ 19	70~75

## Step 5: Connect indoor and outdoor pipe

1. Remove the wire clip; connect the power connection wire and signal control wire (only for cooling and heating unit) to the wiring terminal according to the color, fix them with screws.
2. Fix the power connection wire and signal control wire with wire clip (only for cooling and heating unit).

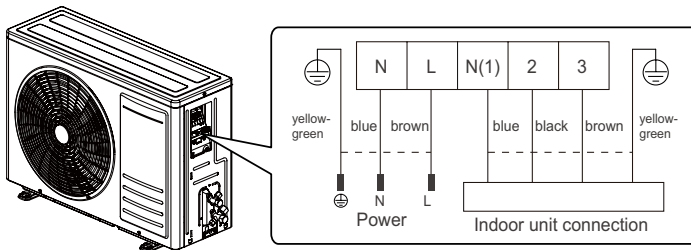

### Note:

- After tighten the screw, pull the power cord slightly to check if it is firm.
- Never cut the power connection wire to prolong or shorten the distance.

# Installation of outdoor unit

## Step 6: Neaten the pipes

1. The pipes should be placed along the wall, bent reasonably and hidden possibly. Min.semidiometer of bending the pipe is 10cm.
2. If the outdoor unit is higher than the wall hole, you must set a U-shaped curve in the pipe before pipe goes into the room, in order to prevent rain from getting into the room.

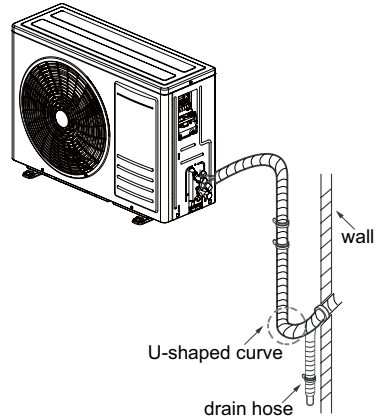

## Step 7: Vacuum pumping

### Use vacuum pump

1. Remove the valve caps on the liquid valve and gas valve and the nut of refrigerant charging vent.
2. Connect the charging hose of piezometer to the refrigerant charging vent of gas valve and then connect the other charging hose to the vacuum pump.
3. Open the piezometer completely and operate for 10-15min to check if the pressure of piezometer remains in  $-0.1\text{MPa}$ .
4. Close the vacuum pump and maintain this status for 1-2min to check if the pressure of piezometer remains in  $-0.1\text{MPa}$ . If the pressure decreases, there may be leakage.
5. Remove the piezometer, open the valve core of liquid valve and gas valve completely with inner hexagon spanner.
6. Tighten the screw caps of valve and refrigerant charging vent.
7. Reinstall the handle.

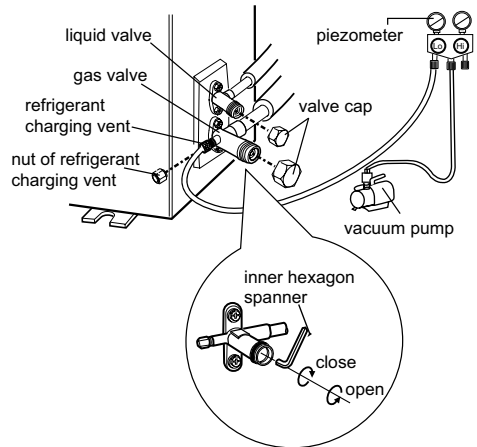

## Step 8: Leakage detection

### 1. With leakage detector:

Check if there is leakage with leakage detector.

### 2. With soap water:

If leakage detector is not available, please use soap water for leakage detection.

Apply soap water at the suspected position and keep the soap water for more than 3min. If there are air bubbles coming out of this position, there's a leakage.

# Check after installation

Check according to the following requirement after finishing installation.

Items to be checked	Possible malfunction
Has the unit been installed firmly?	The unit may drop, shake or emit noise.
Have you done the refrigerant leakage test?	It may cause insufficient cooling (heating) capacity.
Is heat insulation of pipeline sufficient?	It may cause condensation and water dripping.
Is water drained well?	It may cause condensation and water dripping.
Is the voltage of power supply according to the voltage marked on the nameplate?	It may cause malfunction or damaging the parts.
Is electric wiring and pipeline installed correctly?	It may cause malfunction or damaging the parts.
Is the unit grounded securely?	It may cause electric leakage.
Does the power cord follow the specification?	It may cause malfunction or damaging the parts.
Is there any obstruction in the air inlet and outlet?	It may cause insufficient cooling(heating) capacity.
The dust and sundries caused during installation are removed?	It may cause malfunction or damaging the parts.
The gas valve and liquid valve of connection pipe are open completely?	It may cause insufficient cooling(heating) capacity.

# Test operation

## 1. Preparation of test operation

- The client approves the air conditioner.
- Specify the important notes for air conditioner to the client.

## 2. Method of test operation

- Connect the power, press "ON/OFF" button on the remote controller to start operation.
- Press "MODE" button to select AUTO, COOL, DRY, FAN and HEAT to check whether the operation is normal or not.
- If the ambient temperature is lower than 16°C, the air conditioner can't start cooling.

# Configuration of connection pipe

- Standard length of connection pipe
  - 5m, 7.5m, 8m.
- Min length of connection pipe  
For the unit with standard connection pipe of 5m, there is no limitation for the min length of connection pipe. For the unit with standard connection pipe of 7.5m and 8m, the min length of connection pipe is 3m.
- Max. length of connection pipe and max. high difference.

Cooling capacity	Max length of connection pipe	Cooling capacity	Max length of connection pipe
5000Btu/h (1465W)	15	24000Btu/h (7032W)	25
7000Btu/h (2051W)	15	28000Btu/h (8204W)	30
9000Btu/h (2637W)	15	36000Btu/h (10548W)	30
12000Btu/h (3516W)	20	42000Btu/h (12306W)	30
18000Btu/h (5274W)	25	48000Btu/h (14064W)	30

- The additional refrigerant oil and refrigerant charging required after prolonging connection pipe
  - After the length of connection pipe is prolonged for 10m at the basis of standard length, you should add 5ml of refrigerant oil for each additional 5m of connection pipe.
  - The calculation method of additional refrigerant charging amount (on the basis of liquid pipe): **Additional refrigerant charging amount = prolonged length of liquid pipe × additional refrigerant charging amount per meter**
  - Basing on the length of standard pipe, add refrigerant according to the requirement as shown in the table. The additional refrigerant charging amount per meter is different according to the diameter of liquid pipe. See the following sheet.

Additional refrigerant charging amount for R32

Diameter of connection pipe		Indoor unit throttle	Outdoor unit throttle	
Liquid pipe(mm)	Gas pipe(mm)	Cooling only, cooling and heating (g/m)	Cooling only (g/m)	Cooling and heating (g/m)
Φ6	Φ9.52 or Φ12	16	12	16
Φ6 or Φ9.52	Φ16 or Φ19	40	12	40
Φ12	Φ19 or Φ22.2	80	24	96
Φ16	Φ25.4 or Φ31.8	136	48	96
Φ19	-	200	200	200
Φ22.2	-	280	280	280

**Note:**

The additional refrigerant charging amount in Sheet is recommended value, not compulsory.

# Pipe expanding method

Improper pipe expanding is the main cause of refrigerant leakage. Please expand the pipe according to the following steps:

## A: Cut the pipe

Confirm the pipe length according to the distance of indoor unit and outdoor unit.

Cut the required pipe with pipe cutter.

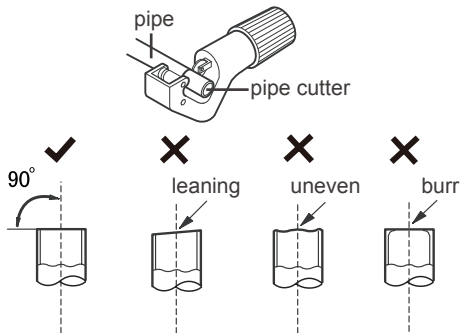

## B: Remove the burrs

Remove the burrs with shaper and prevent the burrs from getting into the pipe.

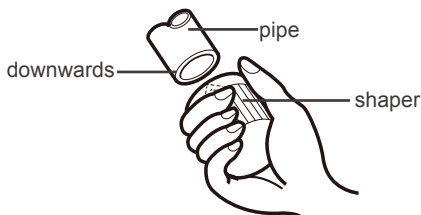

## C: Put on suitable insulating pipe

## D: Put on the union nut

Remove the union nut on the indoor connection pipe and outdoor valve; install the union nut on the pipe.

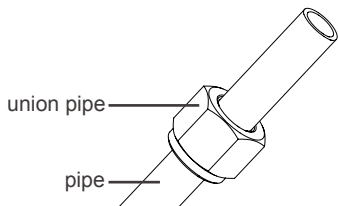

## E: Expand the port

Expand the port with expander.

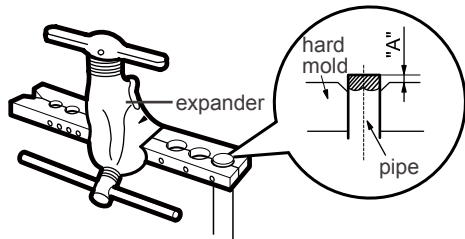

*Note:*

- "A" is different according to the diameter, please refer to the sheet below:

Outer diameter(mm)	A(mm)	
	Max	Min
Φ6 - 6.35(1/4")	1.3	0.7
Φ9.52(3/8")	1.6	1.0
Φ12-12.7(1/2")	1.8	1.0
Φ15.8-16(5/8")	2.4	2.2

## F: Inspection

Check the quality of expanding port. If there is any blemish, expand the port again according to the steps above.

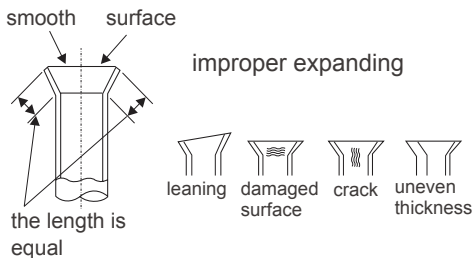

ã { O , ^ • c ! } È |  
VĚH FÁHÁ Ĩ Ĩ Ĩ €€

**WESTERN**<sup>TM</sup>  
AIRCONDITIONING